



GL150N06A8

GL Silicon N-Channel Power MOSFET

General Description

The GL150N06A8 uses advanced trench technology and design to provide excellent RDS(ON) with low gate charge. It can be used in a wide variety of applications. The package form is TO-220, which accords with the RoHS standard.

V _{DSS}	60	V
I _D	150	A
P _D	220	W
R _{DS(ON)type}	3.5	mΩ

Features

- Fast Switching
- Low Gate Charge and R_{dson}
- Low Reverse transfer capacitances
- 100% Single Pulse avalanche energy Test

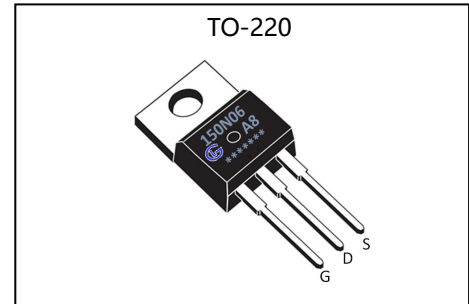

Applications

- Power switching application
- Hard switched and high frequency circuits
- Uninterruptible power supply

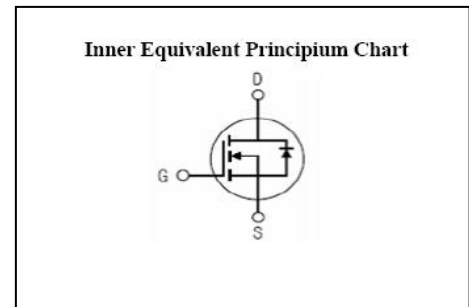

Absolute (T_c= 25°C unless otherwise specified)

Symbol	Parameter	Rating	Units
V _{DSS}	Drain-to-Source Voltage	60	V
I _D	Continuous Drain Current	150	A
	Continuous Drain Current T _c = 100 °C	105	A
I _{DM}	Pulsed Drain Current	600	A
V _{GS}	Gate-to-Source Voltage	±20	V
E _{AS} ^{a2}	Single Pulse Avalanche Energy	1400	mJ
E _{AR} ^{a1}	Avalanche Energy ,Repetitive	50	mJ
I _{AR} ^{a1}	Avalanche Current	65	A
dv/dt ^{a3}	Peak Diode Recovery dv/dt	5.0	V/ns
P _D	Power Dissipation	220	W
T _J , T _{stg}	Operating Junction and Storage Temperature Range	175,-55 to 175	°C
T _L	Maximum Temperature for Soldering	300	°C



GL150N06A8

GL Silicon N-Channel Power MOSFET

Electrical Characteristics (Tc= 25°C unless otherwise specified)

OFF Characteristics						
Symbol	Parameter	Test Conditions	Rating			Units
			Min.	Typ.	Max.	
V _{DSS}	Drain to Source Breakdown Voltage	V _{GS} =0V, I _D =250μA	60	--	--	V
ΔBV _{DSS} /ΔT _J	Bvdss Temperature Coefficient	I _D =250uA, Reference 25°C	--	0.1	--	V/°C
I _{DSS}	Drain to Source Leakage Current	V _{DS} =60V, V _{GS} = 0V, T _a =25°C	--	--	1	μA
		V _{DS} =48V, V _{GS} =0V, T _a =125°C	--	--	250	
I _{GSS(F)}	Gate to Source Forward Leakage	V _{GS} = +20V	--	--	1	μA
I _{GSS(R)}	Gate to Source Reverse Leakage	V _{GS} = -20V	--	--	-1	μA

ON Characteristics						
Symbol	Parameter	Test Conditions	Rating			Units
			Min.	Typ.	Max.	
R _{DS(ON)}	Drain-to-Source On-Resistance	V _{GS} =10V, I _D =75A	--	3.4	4.5	mΩ
V _{GS(TH)}	Gate Threshold Voltage	V _{DS} =V _{GS} , I _D =250μA	2.0	--	4.0	V
Pulse width tp ≤ 380μs, δ ≤ 2%						

Dynamic Characteristics						
Symbol	Parameter	Test Conditions	Rating			Units
			Min.	Typ.	Max.	
g _{fs}	Forward Transconductance	V _{DS} =5V, I _D =75A	180	--	--	S
C _{iss}	Input Capacitance	V _{GS} =0V, V _{DS} =30V f=1.0MHz	--	6500	--	pF
C _{oss}	Output Capacitance		--	650	--	
C _{rss}	Reverse Transfer Capacitance		--	600	--	

Resistive Switching Characteristics						
Symbol	Parameter	Test Conditions	Rating			Units
			Min.	Typ.	Max.	
t _{d(ON)}	Turn-on Delay Time	I _D =30A, V _{DD} =30V V _{GS} =10V, R _G =2.5Ω	--	26	--	ns
t _r	Rise Time		--	25	--	
t _{d(OFF)}	Turn-Off Delay Time		--	90	--	
t _f	Fall Time		--	40	--	
Q _g	Total Gate Charge	I _D =30A, V _{DD} =30V V _{GS} =10V	--	165	--	nC
Q _{gs}	Gate to Source Charge		--	30	--	
Q _{gd}	Gate to Drain ("Miller")Charge		--	65	--	

Source-Drain Diode Characteristics						
Symbol	Parameter	Test Conditions	Rating			Units
			Min.	Typ.	Max.	
I_S	Continuous Source Current (Body Diode)		--	--	150	A
I_{SM}	Maximum Pulsed Current (Body Diode)		--	--	600	A
V_{SD}	Diode Forward Voltage	$I_S=50A, V_{GS}=0V$	--	--	1.5	V
t_{rr}	Reverse Recovery Time	$I_S=40A, T_j=25^\circ C$	--	45	--	ns
Q_{rr}	Reverse Recovery Charge	$di_F/dt=100A/us, V_{GS}=0V$	--	70	--	nC
Pulse width $t_p \leq 380\mu s, \delta \leq 2\%$						

Thermal Characteristics

Symbol	Parameter	Typ.	Units
$R_{\theta JA}$	Junction-to-Ambient	60	$^\circ C/W$
$R_{\theta JC}$	Junction-to-Case	0.68	$^\circ C/W$

^{a1}: Repetitive rating; pulse width limited by maximum junction temperature

^{a2}: EAS condition : $T_j=25^\circ C, V_{DD}=30V, V_G=10V, L=0.5mH, R_g=25\Omega$

^{a3}: $I_{SD}=150A, di/dt \leq 100A/us, V_{DD} \leq BV_{DS}, Start T_j=25^\circ C$

Test Circuits

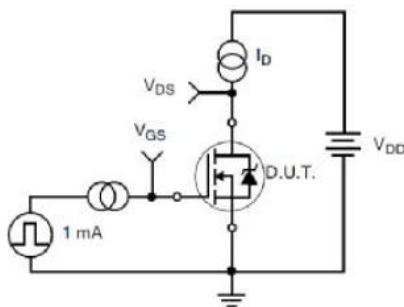

Figure 17. Gate Charge Test Circuit

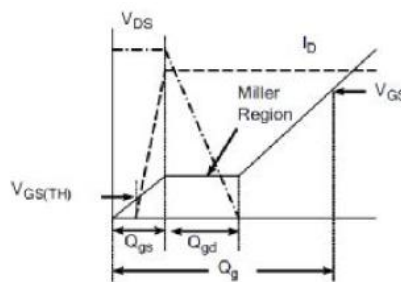

Figure 18. Gate Charge Waveform

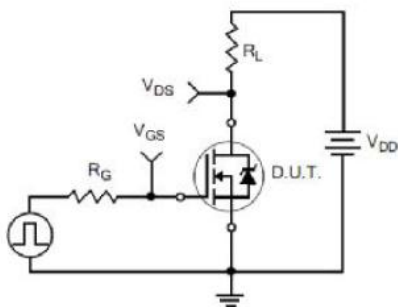

Figure 19. Resistive Switching Test Circuit

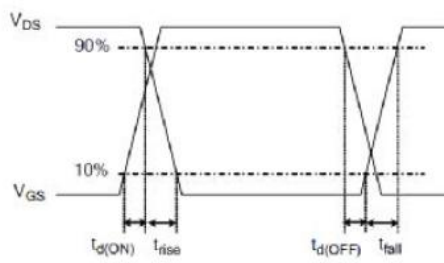

Figure 20. Resistive Switching Waveforms



GL150N06A8

GL Silicon N-Channel Power MOSFET

Characteristics Curves

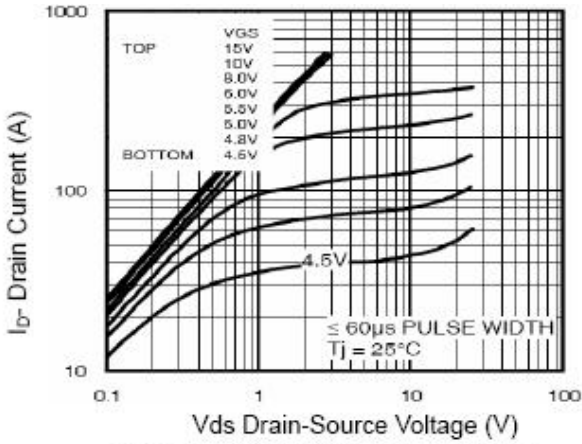

Figure 1 Output Characteristics

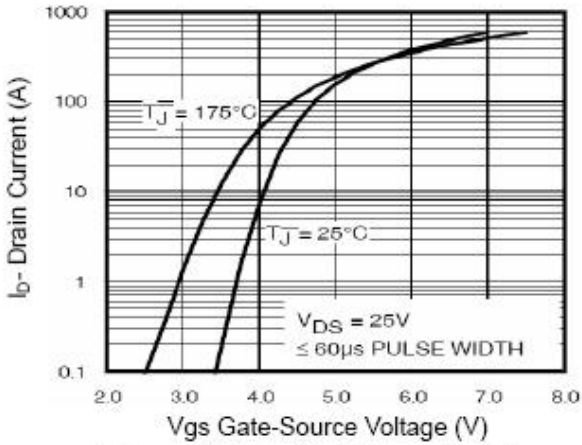

Figure 2 Transfer Characteristics

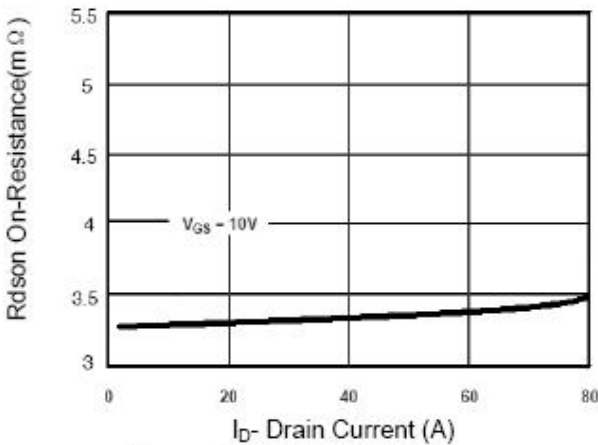

Figure 3 Rdson- Drain Current

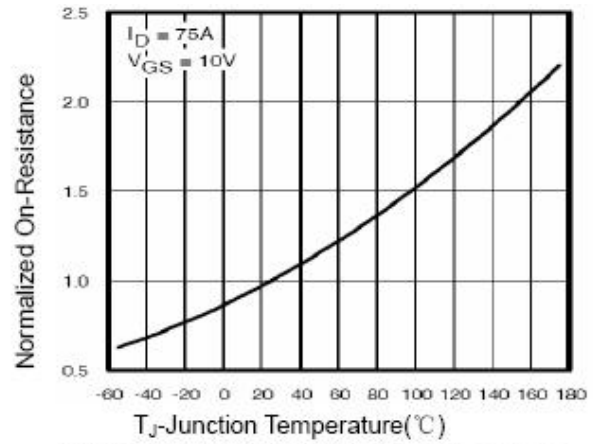

Figure 4 Rdson-Junction Temperature

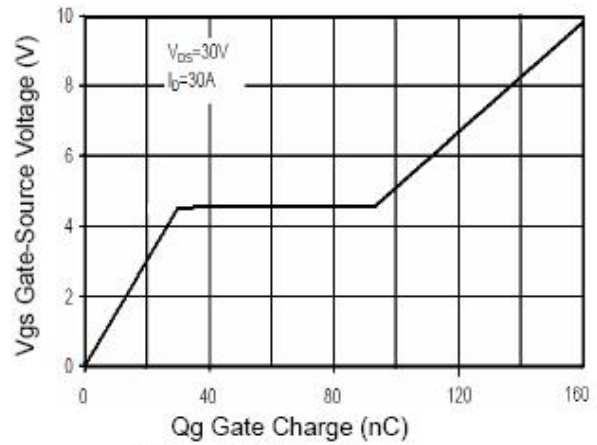

Figure 5 Gate Charge

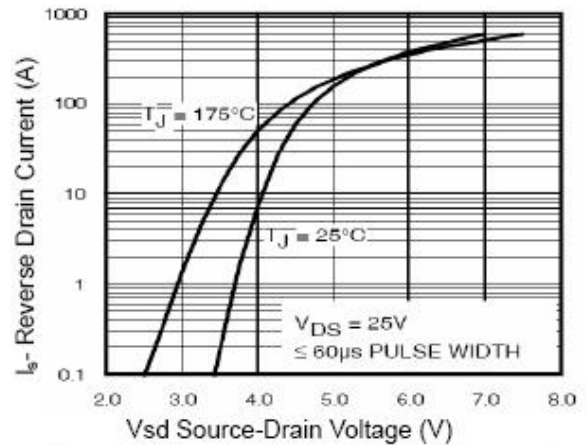

Figure 6 Source- Drain Diode Forward



GL150N06A8

GL Silicon N-Channel Power MOSFET

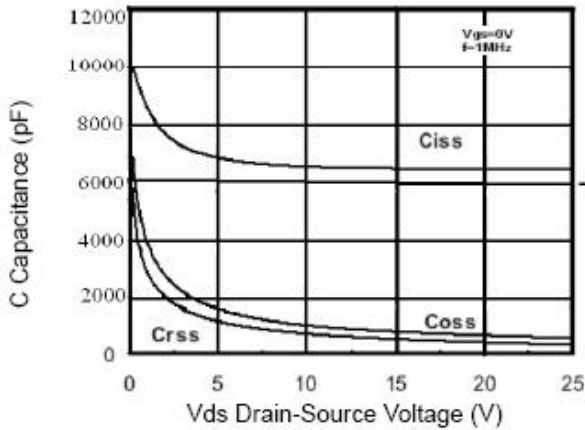

Figure 7 Capacitance vs Vds

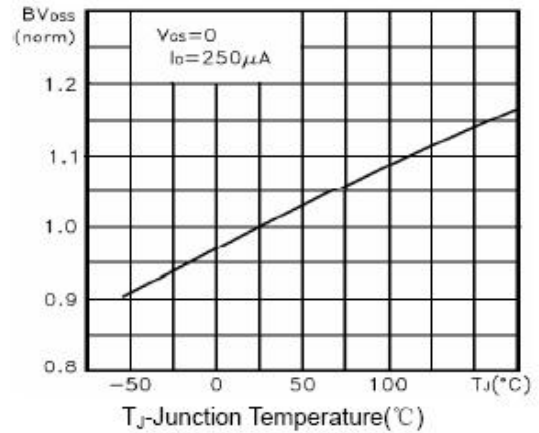

Figure 9 BV_{DSS} vs Junction Temperature

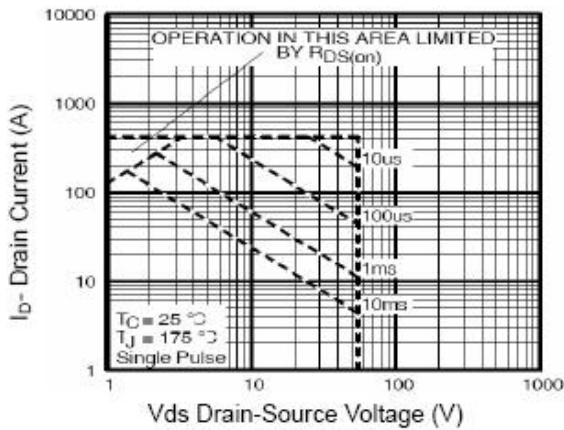

Figure 8 Safe Operation Area

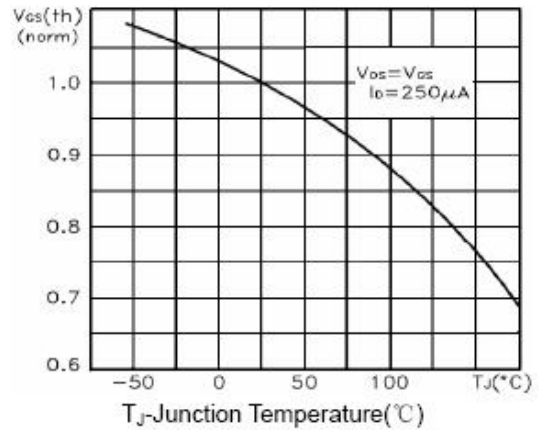

Figure 10 $V_{GS(th)}$ vs Junction Temperature

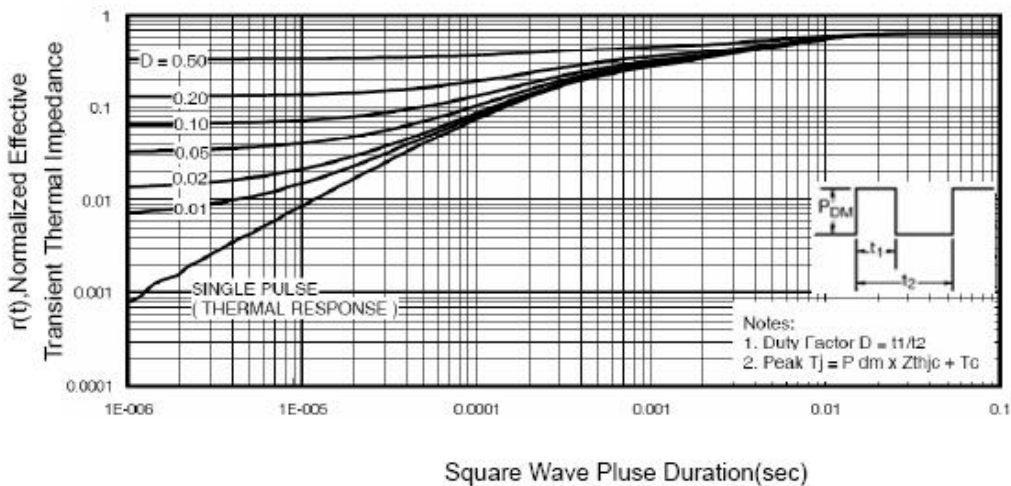

Figure 11 Normalized Maximum Transient Thermal Impedance